

# Saw Man-X

Insert: N Chip breaker (basic/lead angle type <sup>New</sup>), S Chip breaker <sup>New</sup>

Holder: Blade (basic/high pressure coolant <sup>New</sup>), Shank type

## A solution for parting and deep grooving

- Stable machining in deep grooving applying clamping system with strong three-way V-Rail
- Improving clamping precision and convenient replacing of inserts with using the exclusive wrench

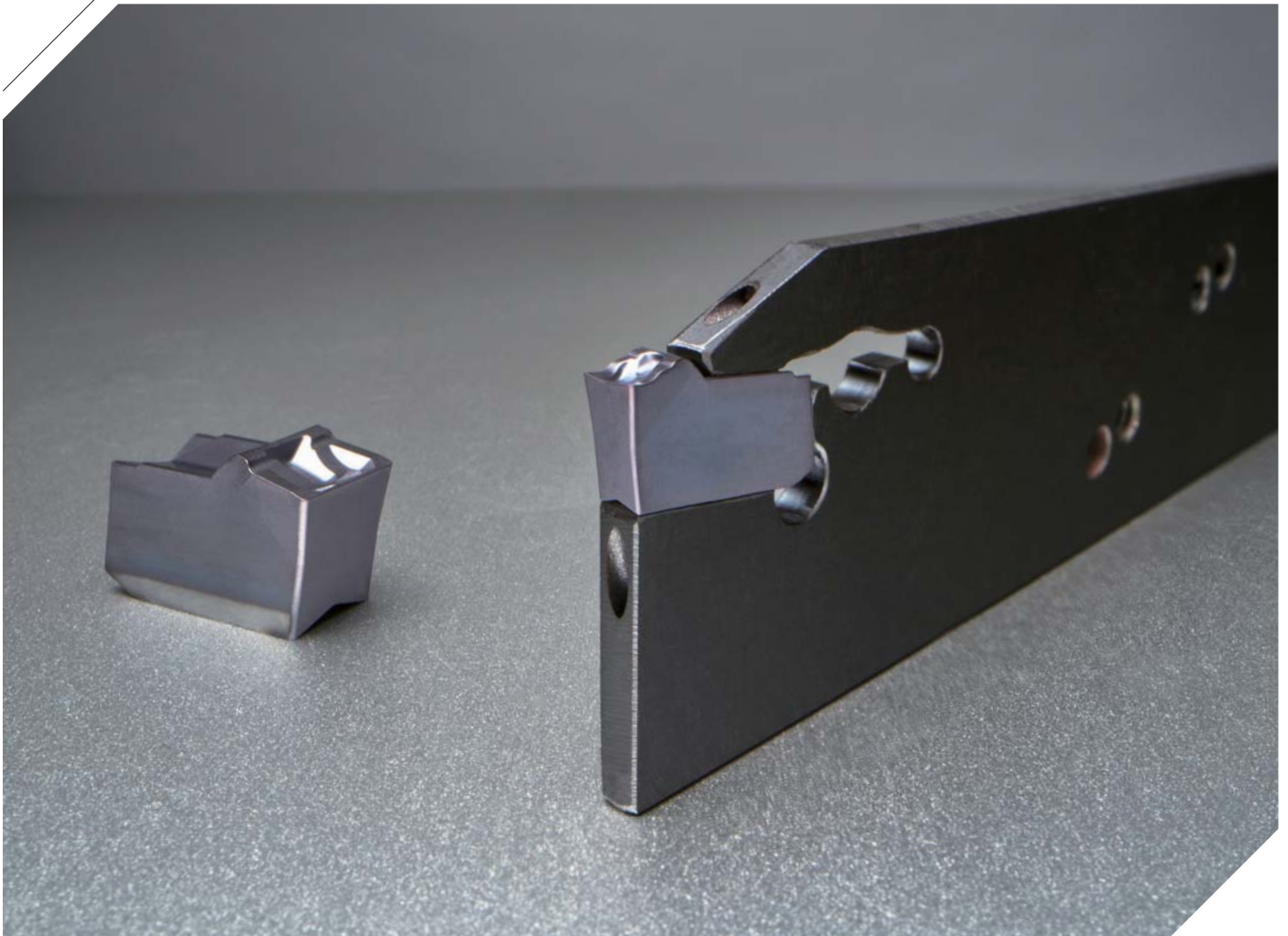

A solution for parting and deep grooving

# Saw Man-X

The stable clamping system of an insert and a holder is the most important factor in parting and deep grooving due to vibration from long overhang, and narrow machining width making unexpected fracture of insert and breakage of holder.

**Saw Man-X insert** with specially designed three-way (top, bottom and back side) concave V-Rail increases the clamping force. In addition, the optimal chip breaker and bump in the back side of insert reduce chip width effectively and minimize scratch and chip curling due to controlling chip radius.

**Saw Man-X holder** has strong clamping structure due to three-way convex V-Rail ensuring perfect clamping insert in the seat of holder. Therefore, it realizes stable clamping in high speed and high feed cutting. Especially blade and block with high pressure internal spraying can maximize cooling efficiency when machining HRSA.

In addition, the exclusive self-clamping structure ensures stable clamping and durability of holder in machining with long overhang. The application of stopper in the back side and exclusive wrench increase repeated clamping precision and make replacing insert easy.

Saw Man-X ensures stable quality of machining, long tool life and convenient clamping system in high speed and high feed machining due to applying three-way V-Rail shape, differentiated chip breaker design and exclusive wrench. Through these advantages, Saw Man-X provides effective and economical solutions in parting and deep grooving.

» **Stable clamping system in high speed and high feed machining**

- Three-way V-Rail structure

» **Enhanced convenience in insert replacement**

- Using the exclusive wrench

» **Optimal chip breaker by workpieces**

- N Chip breaker : steel, cast iron
- S Chip breaker : Stainless steel, HRSA

» **More efficient cooling in applying high pressure inner coolant**

- 2 channel direct spraying on cutting edge
- Longer tool life in HRSA cutting



## Code system

Insert (Basic)				
<b>KSP</b>	<b>300</b>	-	<b>020</b>	- <b>N</b>
KORLOY Saw Man-X Parting	<b>Cutting width</b> 200: 2 mm 300: 3 mm 400: 4 mm		<b>Nose r</b> 020: 0.2 mm 030: 0.3 mm	<b>Chip breaker</b> N: P, K series S: M, S series
Insert (Lead angle type)				
<b>KSP</b>	<b>300</b>	<b>R</b>	-	<b>6D</b> - <b>N</b>
KORLOY Saw Man-X Parting	<b>Cutting width</b> 200: 2 mm 300: 3 mm 400: 4 mm	<b>Hand</b> R: Right handed L: Left handed	<b>Lead angle</b> 4D: 4° 6D: 6°	<b>Chip breaker</b> N: P, K series S: M, S series
Blade				
<b>KSPB</b>	<b>30</b>		<b>32</b>	- <b>(KHP)</b>
KORLOY Saw Man-X Parting Blade	<b>Cutting width</b> 20: 2 mm 30: 3 mm 40: 4 mm		<b>Blade height</b> 26: 26 mm 32: 32 mm	<b>Oil hole</b> None: Without oil hole KHP: High pressure coolant
Shank				
<b>KSPH</b>	<b>3</b>	-	<b>25</b>	<b>R</b>
KORLOY Saw Man-X Parting Holder	<b>Cutting width</b> 2: 2 mm 3: 3 mm 4: 4 mm		<b>Shank size</b> 16: 1616 20: 2020 25: 2525	<b>Hand</b> R: Right handed L: Left handed

## Features

- Three-way V-Rail - More stable clamping system
- Superior chip breaker - Better chip control
- Exclusive wrench - More convenient clamping system
- 2 channel spraying through high pressure coolant - More efficient cooling

### Three-way V-Rail

- Tightly clamped inset in the tip seat
- Increased stability by minimized vibration during the machining
- Available for stable high speed, high feed and high depth of cut machining

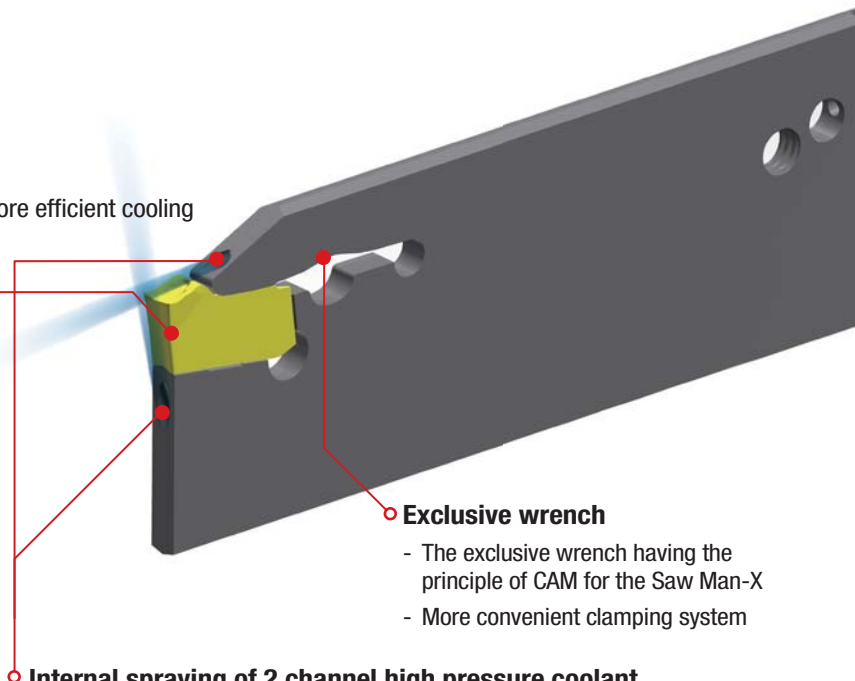
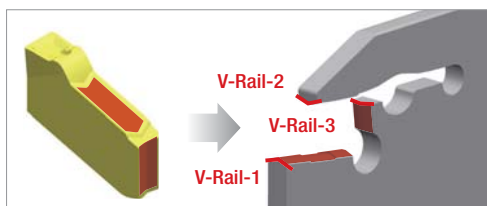

### Internal spraying of 2 channel high pressure coolant

- Direct spraying of cutting edge coolant for effective coolant
- Longer tool life in HRSA cutting  
(\*need for exclusive blade and block for high pressure coolant)

### Exclusive wrench

- The exclusive wrench having the principle of CAM for the Saw Man-X
- More convenient clamping system

## ✔ How to clamp insert

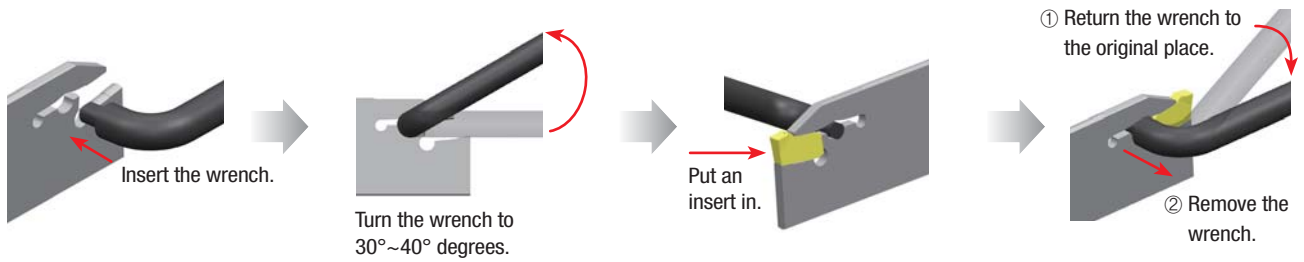

## ✔ Chip breaker features

Type	Shape	Cutting edge	Features
N Chip breaker			<ul style="list-style-type: none"> <li>• 1<sup>st</sup> recommended in steel and cast iron cutting</li> <li>• Negative land cutting edge</li> <li>• For interrupted and high feed cutting</li> </ul>
S Chip breaker <small>New</small>			<ul style="list-style-type: none"> <li>• 1<sup>st</sup> recommended in Stainless steel and HRSA cutting</li> <li>• Sharp cutting edge</li> <li>• For high speed and continuous cutting</li> </ul>
N Chip breaker <small>New</small> (Lead angle type)			<ul style="list-style-type: none"> <li>• Optimal for pipe and round bar cutting</li> <li>• Negative land cutting edge applying lead angle</li> <li>• Minimized burr and size of PIP</li> </ul>

## ✔ Effect of applying lead angle

Insert	Right-handed lead angle	Left-handed lead angle
Controlling PIP size		
Effect	Minimizing PIP size to the direction of cutting part	Minimizing PIP size to the direction of workpiece

### Recommended cutting conditions \_ N Chip breaker

Workpiece				Specific cutting force (N/mm <sup>2</sup> )	Brinell hardness (HB)	Wear resistance ← • → Toughness			Grooving /parting
ISO	Workpiece materials	ISO (DIN)	AISI			High speed and continuous cutting	Medium, interrupted and continuous cutting	Low speed, interrupted and continuous cutting	
						Grade			N
						PC8110	PC3035	PC5300	N
				vc (m/min)			fn (mm/rev)		
P	Non-alloy steel	C35	1035	1600	150	-	140	120	0.28
						-	170	150	0.18
						-	200	180	0.08
		C45	1045	1700	170	-	120	100	0.25
						-	150	120	0.15
	Alloy steel	42CrMo4	4140	1700	180	-	180	160	0.08
						-	120	100	0.25
						-	150	120	0.15
		-	4145	2050	350	-	180	160	0.08
						-	100	80	0.25
M	Austenite series	X5CrNi18-9 (X2CrNi19-11)	304	2000	180	-	150	140	0.08
						80	-	60	0.20
						130	-	120	0.15
		X5CrNiMo17-12-2	316	2000	180	170	-	160	0.06
						80	-	60	0.20
	Gray cast iron	250 (GG25)	No35B	1100	245	130	-	120	0.15
						170	-	160	0.06
						80	-	60	0.20
						100	-	80	0.28
						150	-	120	0.18
Ductile cast iron	450-10	80-55-06	1440	230	200	-	180	0.10	
					80	-	70	0.25	
					130	-	110	0.15	
					180	-	160	0.10	
					180	-	160	0.10	

### Recommended cutting conditions \_ S Chip breaker

Workpiece				Specific cutting force (N/mm <sup>2</sup> )	Brinell hardness (HB)	Wear resistance ← • → Toughness		Grooving /parting
ISO	Workpiece materials	ISO (DIN)	AISI			High speed and continuous cutting	Low speed, interrupted and continuous cutting	
						Grade		S
						PC8110	PC5300	S
				vc (m/min)		fn (mm/rev)		
M	Austenite series	X5CrNi18-9 (X2CrNi19-11)	304	2000	180	80	60	0.20
						150	130	0.15
						180	160	0.06
	-	X5CrNiMo17-12-2	316	2000	180	80	60	0.20
						150	130	0.15
						180	160	0.06
S	Steel series	-	Inconel909	2400	200	65	55	0.15
						80	70	0.10
						95	85	0.05
	Ni series	15156-3	Inconel625	2650	250	45	35	0.15
						60	50	0.10
						75	65	0.05
		9723	Inconel718	2900	350	30	25	0.15
						40	35	0.10
						50	45	0.05
	Titanium alloy	-	B265 (ASTM)	1300	400	45	35	0.15
						60	50	0.10
						75	65	0.05
5832-11		Ti-6Al-4V	1400	950	35	25	0.15	
					50	40	0.10	
					65	55	0.05	

## ✓ Recommended cutting conditions \_ N Chip breaker (Lead angle type)

Workpiece				Specific cutting force (N/mm <sup>2</sup> )	Brinell hardness (HB)	Wear resistance ← ● → Toughness			Grooving /parting
ISO	Workpiece materials	ISO (DIN)	AISI			High speed and continuous cutting	Medium, interrupted and continuous cutting	Low speed, interrupted and continuous cutting	
						Grade			- □ D-N
						PC8110	PC3035	PC5300	
P	Non-alloy steel	C35	1035	1600	150	-	140	120	0.18
						-	170	150	0.12
						-	200	180	0.06
		C45	1045	1700	170	-	120	100	0.18
						-	150	120	0.12
	Alloy steel	42CrMo4	4140	1700	180	-	180	160	0.06
						-	120	100	0.18
						-	150	120	0.12
		-	4145	2050	350	-	180	160	0.06
						-	100	80	0.18
M	Austenite series	X5CrNi18-9 (X2CrNi19-11)	304	2000	180	80	-	60	0.18
						130	-	120	0.12
						170	-	160	0.06
		X5CrNiMo17-12-2	316	2000	180	80	-	60	0.18
						130	-	120	0.12
	Gray cast iron	250 (GG25)	No35B	1100	245	170	-	160	0.06
						100	-	80	0.18
						150	-	120	0.12
						200	-	180	0.06
						Ductile cast iron	450-10	80-55-06	1440
130	-	110	0.12						
180	-	160	0.06						

## ✓ Grade features

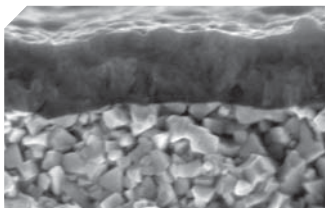

**PC3035** *New*

**P**

- Exclusive substrate ensuring stable cutting and exclusive grade with good wear resistance for steel machining
  - New TiAlN layer with excellent wear resistance and high temperature hardness
  - Exclusive substrate realizing fracture resistance and stable cutting for steel grooving

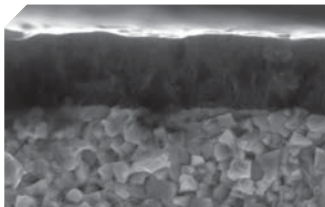

**PC5300**

**P M K S**

- High toughness ultra-fine substrate and universal grade applying high hardness and wear resistance coating layer
  - New TiAlN layer with excellent wear resistance and high temperature hardness
  - Ultra-fine substrate with good chipping resistance and high toughness

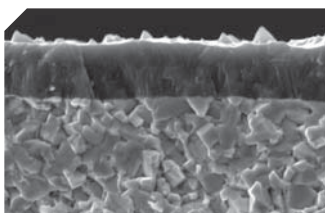

**PC8110**

**M K S**

- Suitable substrate at high temperature and grade applying PVD coating layer for hard-to-cut materials and cast iron cutting
  - PVD coating layer with high temperature hardness and high temperature oxidation resistance
  - Substrate good for high wear resistance and plastic deformation resistance under high temperature



## Performance evaluation

### N Chip breaker

<b>Workpiece</b>	Alloy steel (42CrMo4), Ø100
<b>Cutting conditions</b>	vc(m/min) = 150, fn(mm/rev) = 0.15, ap(mm) = 15, wet
<b>Tools</b>	<b>Insert</b> KSP300-020-N(PC5300) <b>Holder</b> KSPB3026



[ Saw Man-X ]



[ Competitor ]

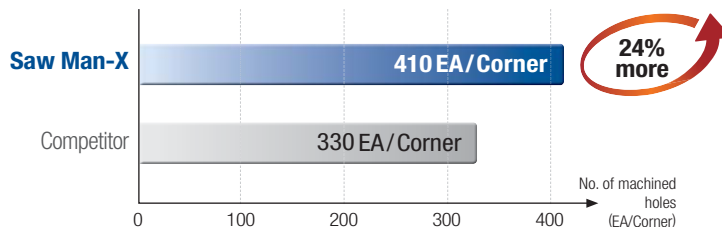

### S Chip breaker

<b>Workpiece</b>	Stainless steel (X5CrNi18-9), Ø100
<b>Cutting conditions</b>	vc(m/min) = 120, fn(mm/rev) = 0.15, ap(mm) = 7, wet
<b>Tools</b>	<b>Insert</b> KSP300-02-S(PC5300) <b>Holder</b> KSPB3026



[ Saw Man-X ]



[ Competitor ]

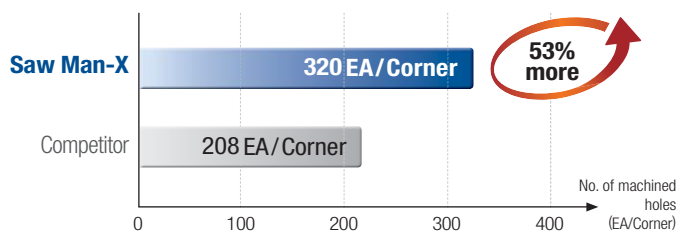

### N Chip breaker (Lead angle type)

<b>Workpiece</b>	Alloy steel (42CrMo4), Ø100
<b>Cutting conditions</b>	vc(m/min) = 120, fn(mm/rev) = 0.12, ap(mm) = 10 (Parting), wet
<b>Tools</b>	<b>Insert</b> KSP300R-6D-N(PC5300) <b>Holder</b> KSPB3026



[ Saw Man-X ]



[ Competitor ]

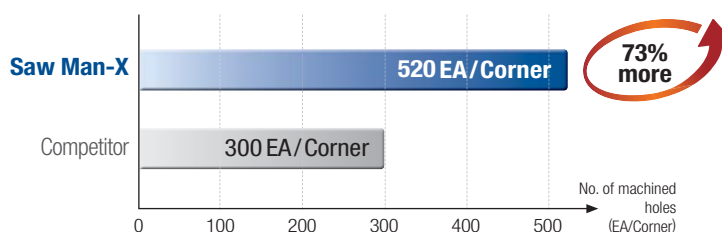

### High pressure coolant

<b>Workpiece</b>	HRS A (9723), Ø50
<b>Cutting conditions</b>	vc(m/min) = 50, fn(mm/rev) = 0.10, ap(mm) = 3, wet
<b>Tools</b>	<b>Insert</b> KSP300-020-S(PC5300) <b>Holder</b> KSPB3026-KHP



[ 70 bar internal spraying ]



[ External spraying ]

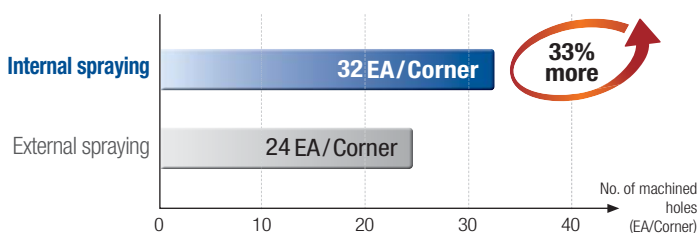

## Tool selection guide

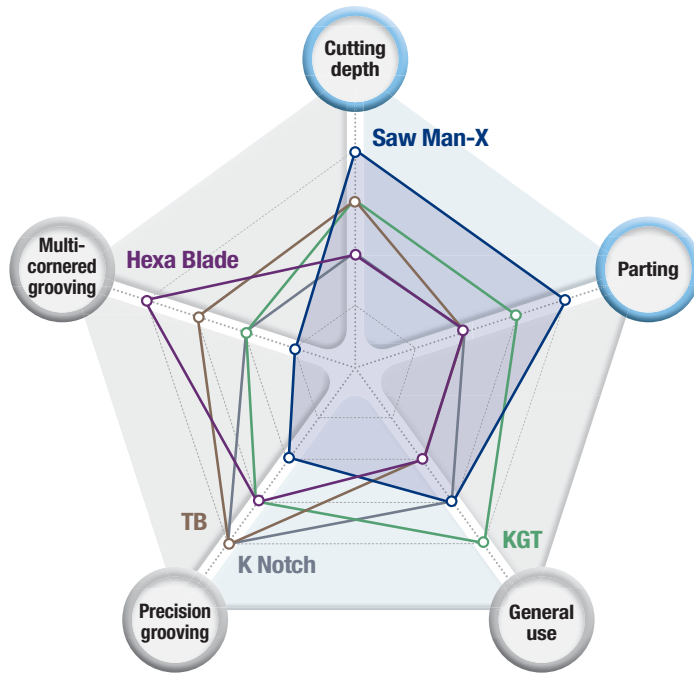

### Saw Man-X <sup>New</sup>

- 1 cornered insert
- Optimal for interrupted and high feed parting
- Deep grooving



### Hexa Blade <sup>New</sup>

- Precision typed and 6 cornered insert
- High cost efficiency
- Precision grooving and multi-cornered grooving



### TB

- Precision typed and 3 cornered insert
- Optimal for automatic cutting
- Precision grooving



### KGT

- 2 cornered insert
- Various applications
- For general use



### K Notch

- Precision typed and 2 cornered insert
- Strong clamping system
- Precision grooving

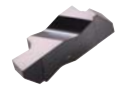





Tools	Cutting depth	Parting	General use	Precision grooving	Multi-cornered grooving
Saw Man-X <sup>New</sup>	★★★★★	★★★★★	★★★	★★	★
Hexa Blade <sup>New</sup>	★★	★★	★★	★★★★	★★★★★
TB	★★★	★★	★★	★★★★★	★★★
KGT	★★★	★★★	★★★★★	★★★	★★
K Notch	★★	★★	★★★	★★★★★	★★







## ✓ Cutting width and cutting depth by tools

⊙: 1<sup>st</sup> recommendation ○: 2<sup>nd</sup> recommendation

Tools	Cutting width (mm)				No. of edges	Machining				Features
	2	4	6	8		External	Internal	Facing	Parting	
	5	10	20	60						
Cutting depth maximum (mm)										
<b>Saw Man-X</b>  <i>New</i>	2.0	6.0		60.0	1	○			⊙	<ul style="list-style-type: none"> <li>• Various lead angles</li> <li>• Minimizing burr</li> </ul>
<b>Hexa Blade</b>  <i>New</i>	1.78	4.0		5.0	6	⊙			○	<ul style="list-style-type: none"> <li>• Precision type</li> <li>• High cost efficient cutting</li> </ul>
<b>TB</b> 	1.25	6.0		6.5	3	⊙			○	<ul style="list-style-type: none"> <li>• Precision type</li> <li>• Optimal for automated machining</li> </ul>
<b>KGT</b> 	1.5	8.0		28.0	2	⊙	○	○	⊙	<ul style="list-style-type: none"> <li>• For various kinds of cutting</li> <li>• For general cutting range</li> </ul>
<b>K Notch</b> 	0.75	6.3		6.5	2	⊙				<ul style="list-style-type: none"> <li>• Precision type</li> <li>• Strong clamping system</li> </ul>

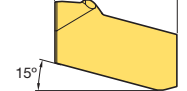
## ✓ Insert

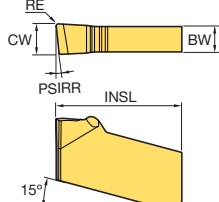
Picture	Designation	Coated			Dimensions (mm)					Geometries
		PC3035	PC5300	PC8110	CW	RE	INSL	PSIRR	BW	
	<b>KSP</b> 200-020-N	●	●	●	2.0	0.20	11.0	-	1.6	
	300-020-N	●	●	●	3.0	0.20	12.0	-	2.5	
	400-025-N	●	●	●	4.0	0.25	12.5	-	3.3	
	500-025-N	●	●	●	5.0	0.25	13.5	-	4.3	
	600-035-N	●	●	●	6.0	0.35	14.5	-	5.3	
 <i>New</i>	<b>KSP</b> 200-020-S		●	●	2.0	0.20	11.1	-	1.6	
	300-020-S		●	●	3.0	0.20	12.1	-	2.5	
	400-025-S		●	●	4.0	0.25	12.6	-	3.3	
	500-025-S		●	●	5.0	0.25	13.5	-	4.3	
	600-035-S		●	●	6.0	0.35	14.5	-	5.3	
 <i>New</i>	<b>KSP</b> 200R-6D-N	●	●	●	2.0	0.20	11.1	6°	1.6	
	200L-6D-N	●	●	●	2.0	0.20	11.1	6°	1.6	
	300R-6D-N	●	●	●	3.0	0.20	12.1	6°	2.5	
	300L-6D-N	●	●	●	3.0	0.20	12.1	6°	2.5	
	400R-4D-N	●	●	●	4.0	0.25	12.6	4°	3.3	
	400L-4D-N	●	●	●	4.0	0.25	12.6	4°	3.3	

●: Stock item

# KSPB (Blade)



KSP

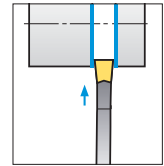
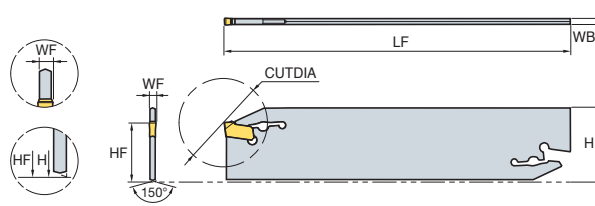

Designation		Stock	Cutting width	CUTDIA	H	WB	LF	HF	WF	Wrench
KSPB	2026	●	2	50	26	1.6	110	21	1.8	CW08
	2032	●	2	52	32	1.6	150	25	1.8	
	3026	●	3	72	26	2.4	110	21	2.7	
	3032	●	3	120	32	2.4	150	25	2.7	
	4026	●	4	72	26	3.2	110	21	3.6	
	4032	●	4	120	32	3.2	150	25	3.6	
	5026		5	80	26	4.0	110	21	4.5	CW10
	5032	●	5	120	32	4.0	150	25	4.5	
	6026		6	120	26	5.2	110	21	5.6	
	6032	●	6	120	32	5.2	150	25	5.6	

(mm)

●: Stock item

# SMBB (Block)



KSPB□□□□  
 SPB□□□(-S)  
 KGTB□□□□(S)

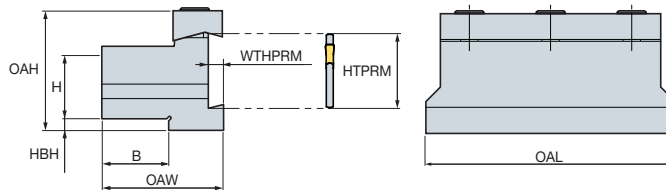

Designation		Stock	H	B	HTPRM	OAL	OAH	HBH	OAW	WTHPRM	Screw	Wrench
SMBB	1626	●	16	12	26	86	43	13	30	5.3	BHA0620	HW50L
	2026	●	20	19	26	86	43	9	38	5.3		
	2032	●	20	19	32	100	50	13	38	5.3		
	2526	●	25	23	26	86	43	4	42	5.3		
	2532	●	25	23	32	110	50	8	42	5.3		
	3232	●	32	30	32	110	54	5	48	5.3		

(mm)

●: Stock item

# KSPH (Shank)



KSP

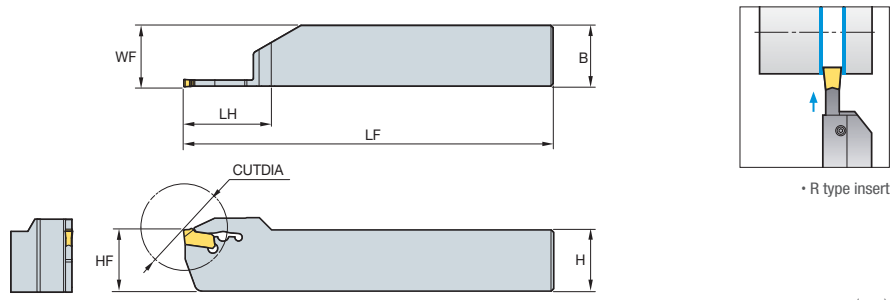

(mm)

Designation	Stock		Cutting width	H=(HF)	B	LH	LF	CUTDIA	WF	Wrench
	R	L								
<b>KSPH</b> 216R/L			2	16	16	31	100	46	16.2	CW08
220R/L			2	20	20	32	120	48	20.2	
225R/L	●		2	25	25	33	150	50	25.2	
316R/L			3	16	16	34	100	52	16.2	
320R/L	●		3	20	20	35	120	54	20.2	
325R/L	●		3	25	25	36	150	56	25.2	
420R/L	●		4	20	20	40	120	64	20.4	
425R/L	●		4	25	25	41	150	66	25.4	
520R/L			5	20	20	45	120	74	20.4	CW10
525R/L	●		5	25	25	46	150	76	25.4	
625R/L	●		6	25	25	46	150	76	25.4	

●: Stock item

# KSPB (Blade) New!

High pressure coolant



KSP

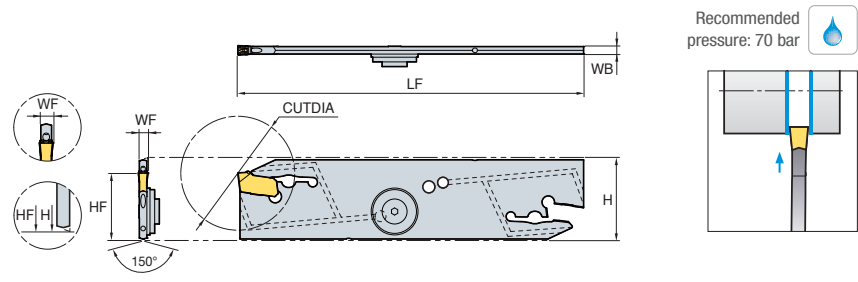

(mm)

Designation	Stock	Cutting width	CUT DIA	H	WB	LF	HF	WF	Wrench	Copper washer	Sealing plate	Sealing screw
4026-KHP	●	4	72	26	3.4	110	21	3.7				

●: Stock item

# SMBB (Block) New!

High pressure coolant

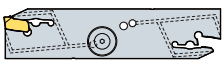

KSPB□□□□-KHP

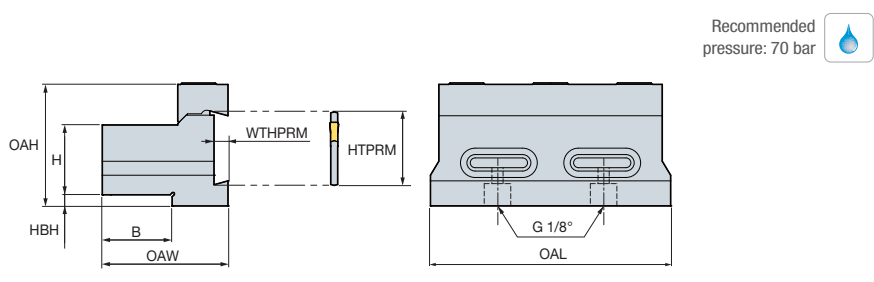







(mm)

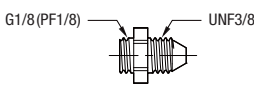

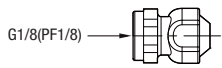
Designation	Stock	H	B	HTPRM	OAL	OAH	HBH	OAW	WTHPRM	Screw	Wrench	O-ring
2526-KHP	●	25	25	26	86	43.5	4	45	5			

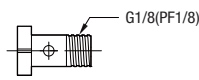
●: Stock item

## Connecting parts

Parts	Designation	Shape of parts	
Adaptor	HPA3/8UNF1/8PF		
Blank	HPB1/8PF		
Banjo screw	HPZ1/8PF		
Copper washer	HPW1/8PF		

## High pressure hose

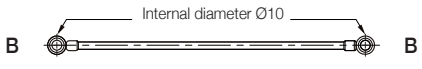
The shape of the high pressure hose		Length	Standard S	Standard B
Straight to straight (HPH3/8UNF)		200 mm	UNF3/8	-
		250 mm		
Straight to banjo (HPH3/8UNF1/8PF)		200 mm	UNF3/8	Internal diameter Ø10
		250 mm		
Banjo to banjo (HPH1/8PF)		200 mm	-	Internal diameter Ø10
		250 mm		

### Notice

- Use a proper spanner for clamping up to the specs.
- Be careful of coolant injection by the residual pressure while using high pressure coolant.
- Clamp the parts completely before usage.
- Clean the turning machine before clamping.
- The O-ring is included in the parts. Don't have to purchase it separately.

### ⚠ For the safe metalcutting

- Use safety supplies such as protective gloves to prevent possible injury while touching the edge of tools.
- Use safety glasses or safety cover to hedge possible dangers. Inappropriate usage or excessive cutting condition may lead tool's breakage or even the fragment's scattering.
- Clamp the workpiece tightly enough to prevent its movement while its machining.
- Properly manage the tool change phase because the inordinately used tool can be easily broken under the excessive cutting load or severe wear, and it may threat the operator's safety.
- Use safety cover because chips evacuated during cutting are hot and sharp and may cause burns and cuts. To remove chips safely, stop machining, put on protective gloves, and use a hook or other tools.
- Prepare for fire prevention measures as the use of the non-water soluble cutting oil may cause fire.
- Use safety cover and other safety supplies because the spare parts or the inserts can be pulled out due to centrifugal force while high speed machining.



**Head Office:** Holystar B/D, 326, Seocho-daero, Seocho-gu, Seoul, 06633, Republic of Korea  
Tel: +82-2-522-3181 Fax: +82-2-522-3184, +82-2-3474-4744 Web: [www.korloy.com](http://www.korloy.com) E-mail: [sales.khq@korloy.com](mailto:sales.khq@korloy.com)

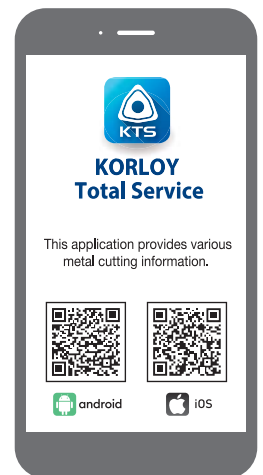

### **KORLOY AMERICA**

620 Maple Avenue, Torrance, CA 90503, USA  
Tel: +1-310-782-3800 Toll Free: +1-888-711-0001 Fax: +1-310-782-3885  
E-mail: [sales.kai@korloy.com](mailto:sales.kai@korloy.com)

### **KORLOY INDIA**

Plot No. 415, Sector 8, IMT Manesar, Gurgaon 122051, Haryana, India  
Tel: +91-124-4391790 Fax: +91-124-4050032  
E-mail: [sales.kip@korloy.com](mailto:sales.kip@korloy.com)

### **KORLOY TURKIYE**

Serifali Mahallesi, Burhan Sokak NO: 34  
Dudullu OSB/Umraniye/Istanbul, 34775, Turkey  
Tel: +90-216-415-8874 E-mail: [sales.ktl@korloy.com](mailto:sales.ktl@korloy.com)

### **KORLOY RUSSIA**

Krasivy Dom office No. 305, Bld. 5, Novovladykinskiy proezd 8, 127106,  
Moscow, Russia  
Tel: +7-495-280-1458 Fax: +7-495-280-1459 E-mail: [sales.krc@korloy.com](mailto:sales.krc@korloy.com)

### **KORLOY FACTORY INDIA**

Plot No. 415, Sector 8, IMT Manesar, Gurgaon 122051, Haryana, India  
Tel: +91-124-4391790 Fax: +91-124-4050032  
E-mail: [pro.kim@korloy.com](mailto:pro.kim@korloy.com)

### **KORLOY EUROPE**

Gablonzer Str. 25-27, 61440 Oberursel, Germany  
Tel: +49-6171-277-83-0 Fax: +49-6171-277-83-59  
E-mail: [sales.keg@korloy.com](mailto:sales.keg@korloy.com)

### **KORLOY BRASIL**

Av. Aruana 280, conj.12, WLC, Alphaville, Barueri,  
CEP06460-010, SP, Brasil  
Tel: +55-11-4193-3810 E-mail: [sales.kbl@korloy.com](mailto:sales.kbl@korloy.com)

### **KORLOY CHILE**

Av. Providencia 1650, Office 1009, 7500027  
Providencia-Santiago, Chile  
Tel: +56-229-295-490 E-mail: [sales.kcs@korloy.com](mailto:sales.kcs@korloy.com)

### **KORLOY MEXICO**

Calle R. M. Clemencia Borja Taboada 522, Jurica Acueducto,  
76230 Juriquilla, Qro., Mexico  
Tel: +52-442-673-7388 E-mail: [sales.kml@korloy.com](mailto:sales.kml@korloy.com)

